

**BLACK & DECKER®**  
**CORDLESS**

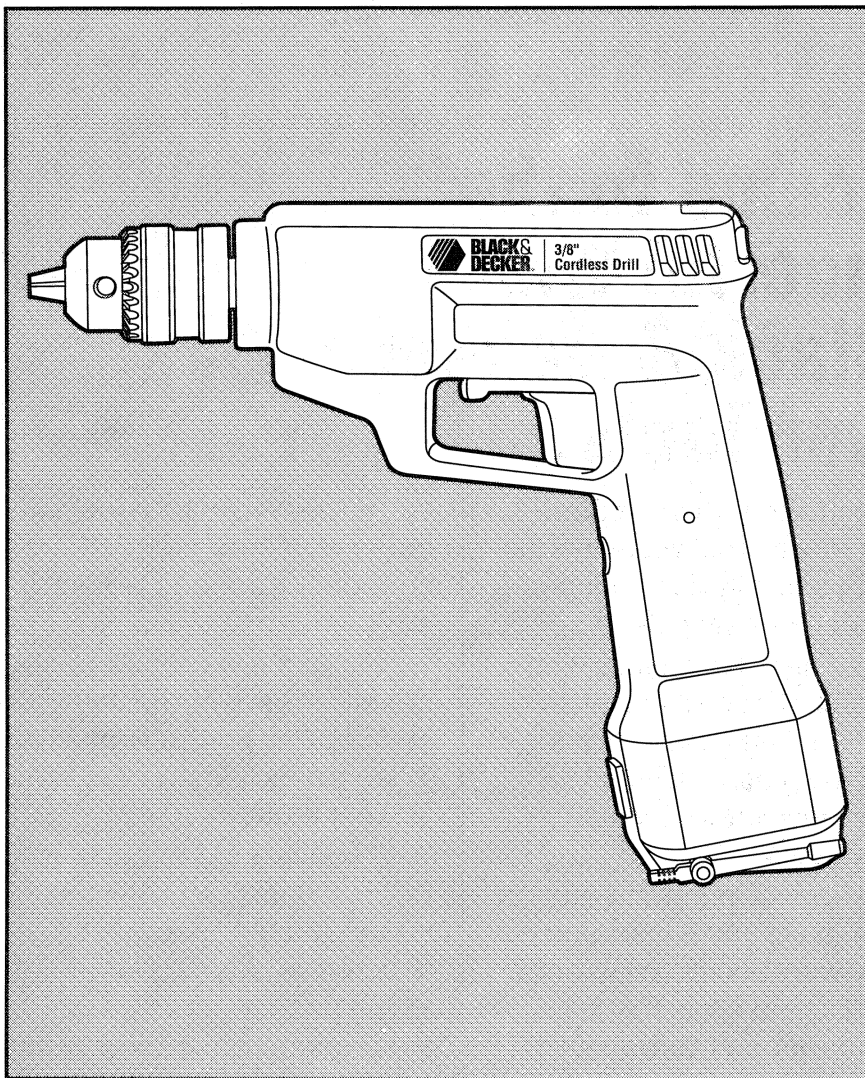

**Instruction Manual**  
**3/8" Compact Cordless Drill**

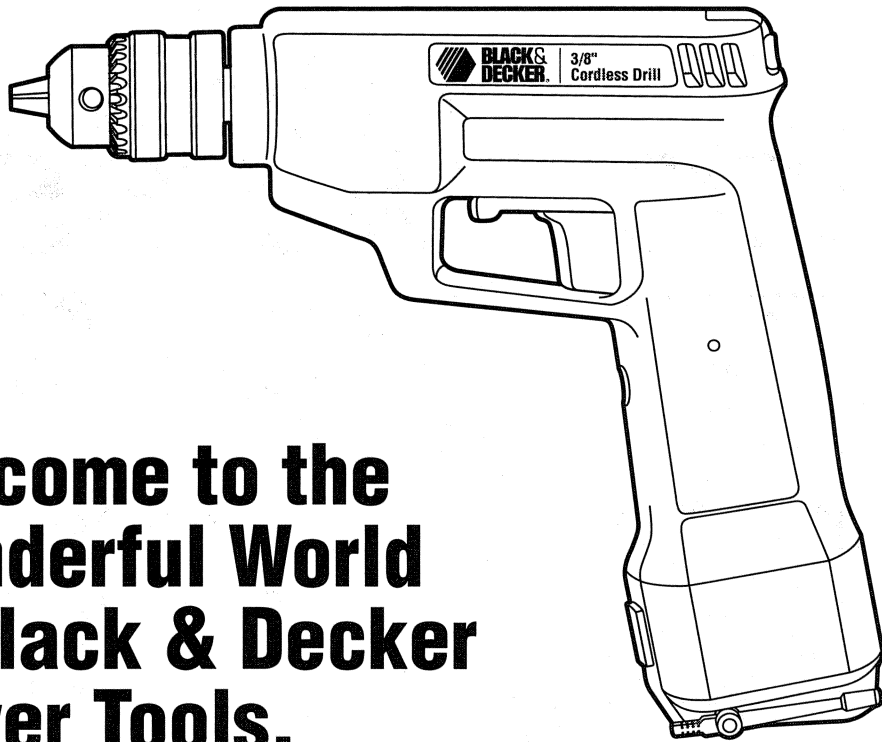

# Welcome to the Wonderful World of Black & Decker Power Tools.

If you already own a Black & Decker Power Tool you know the pleasure a quality, high performance tool can deliver.

Your new 3/8" Compact Cordless Drill is built in that same tradition that has kept Black & Decker the most respected name in power tools for over seventy years.

Full power in forward and reverse, a big 3/8" chuck, and no cord to worry about...ever, make your drill a real value that will deliver power and convenience for years to come.

A convenient charger is included to keep your drill constantly fresh and ready for work.

Take a few minutes to read this informative instruction manual. Pay particular attention to the safety rules we've provided for your protection.

We want you to enjoy your Black & Decker tool and the more you know about it and its capabilities, the happier you'll be with it.

Don't forget to send in your owner's registration card.

Thanks for selecting Black & Decker!



**BLACK & DECKER®**

## IMPORTANT SAFETY INSTRUCTIONS

**WARNING:** When using Electric Tools, basic safety precautions should always be followed to reduce risk of fire, electric shock, and personal injury, including the following:

**NOTE:** The following safety instructions contain some references that only make sense for corded tools. Although your new drill is cordless, it's a good practice to review all of the instructions.

### READ ALL INSTRUCTIONS

1. **KEEP WORK AREA CLEAN.** Cluttered areas and benches invite injuries.
2. **CONSIDER WORK AREA ENVIRONMENT.** Don't expose power tools to rain. Don't use power tools in damp or wet locations. Keep work area well lit.
3. **GUARD AGAINST ELECTRIC SHOCK.** Prevent body contact with grounded surfaces. For example: pipes, radiators, ranges, refrigerator enclosures.
4. **KEEP CHILDREN AWAY.** All visitors should be kept away from work area. Do not let visitors contact tool or extension cord.
5. **STORE IDLE TOOLS.** When not in use, tools should be stored in dry, and high or locked-up place - out of reach of children.
6. **DON'T FORCE TOOL.** It will do the job better and safer at the rate for which it was intended.
7. **USE RIGHT TOOL.** Don't force small tool or attachment to do the job of a heavy-duty tool. Don't use tool for purpose not intended, for example, don't use circular saw for cutting tree limbs or logs.
8. **DRESS PROPERLY.** Do not wear loose clothing or jewelry. They can be caught in moving parts. Rubber gloves and non-skid footwear are recommended when working outdoors. Wear protective hair covering to contain long hair.
9. **USE SAFETY GLASSES.** Also use face or dustmask if cutting operation is dusty.
10. **DON'T ABUSE CORD.** Never carry tool by cord or yank it to disconnect from receptacle. Keep cord from heat, oil, and sharp edges.
11. **SECURE WORK.** Use clamps or a vise to hold work. It's safer than using your hand and it frees both hands to operate tool.
12. **DON'T OVERREACH.** Keep proper footing and balance at all times.
13. **MAINTAIN TOOLS WITH CARE.** Keep tools sharp and clean for better and safe performance. Follow instructions for lubricating and changing accessories. Inspect tool cords periodically and if damaged have repaired by authorized service facility. Inspect extension cords periodically and replace if damaged. Keep handles dry, clean, and free from oil and grease.
14. **DISCONNECT TOOLS.** When not in use, before servicing, and when changing accessories, such as blades, bits, cutters.
15. **REMOVE ADJUSTING KEYS AND WRENCHES.** Form habit of checking to see that keys and adjusting wrenches are removed from tool before turning it on.
16. **AVOID UNINTENTIONAL STARTING.** Don't carry plugged-in tool with finger on switch. Be sure switch is off when plugging in.
17. **OUTDOOR USE EXTENSION CORDS.** When tool is used outdoors, use only extension cords intended for use outdoors and so marked.
18. **STAY ALERT.** Watch what you are doing. Use common sense. Do not operate tool when you are tired.
19. **CHECK DAMAGED PARTS.** Before further use of the tool, a guard or other part that is damaged should be carefully checked to determine that it will operate properly and perform its intended function. Check for alignment of moving parts, binding of moving parts, breakage of parts, mounting, and any other conditions that may affect its operation. A guard or other part that is defective should be properly repaired or replaced by an authorized service center unless otherwise indicated elsewhere in this instruction manual. Have defective switches replaced by authorized service center. Do not use tool if switch does not turn it on and off.
20. **DO NOT OPERATE** portable electric tools near flammable liquids or in gaseous or explosive atmospheres. Motors in these tools normally spark, and the sparks might ignite fumes.

## SAVE THESE INSTRUCTIONS

## Additional Drill Safety Rules

1. Be aware that this tool is always in an operating condition, because it does not have to be plugged into an electrical outlet. Keep the switch control lever in LOCK-"OFF" (9016, 6091 & 9912 only) position (Figure 5) when not using tool or when changing accessories.
2. When drilling or driving screws into walls, floors or wherever "live" electrical wires may be encountered, **DO NOT TOUCH ANY FRONT METAL PARTS OF THE TOOL!** Hold the tool only by the plastic handle to prevent electric shock if you drill or drive into a "live" wire.

## Important Charger & Drill Safety Instructions

1. **SAVE THESE INSTRUCTIONS** – This manual contains important safety and operating instructions.
2. Before using battery charger, read all instructions and cautionary markings on battery charger and drill.
3. The charger and drill are specifically designed to work together. **DO NOT** attempt to charge any other cordless tool or battery pack with this charger. **DO NOT** attempt to charge the drill with any other charger than the one supplied with the tool.
4. Do not expose charger to rain or snow.
5. The battery charger is not intended for any uses other than charging the product shown in this manual. Other uses may result in risk of fire or electric shock.
6. To reduce the risk of damage to electric plug and cord, pull by plug rather than cord when disconnecting charger.

7. Make sure cord is located so that it will not be stepped on, tripped over, or otherwise subjected to damage or stress.
8. An extension cord should not be used unless absolutely necessary. Use of improper extension cord could result in risk of fire and electric shock. If extension cord must be used, make sure:
  - a. That pins on plug of extension cord are the same number, size, and shape as those of plug on charger;
  - b. That extension cord is properly wired and in good electrical condition; and
  - c. That wire is large enough for AC ampere rating of charger as specified in Table 1 (see Table that follows).
9. Do not operate charger with damaged cord or plug - replace them immediately.
10. Do not operate charger if it has received a sharp blow, been dropped, or otherwise damaged in any way; take it to a qualified Black & Decker Service Center.
11. Do not disassemble charger; take it to a qualified Black & Decker Service Center when service or repair is required. Incorrect reassembly may result in risk of electric shock or fire. There are no consumer serviceable parts inside.
12. To reduce risk of electric shock, unplug charger from outlet before cleaning.
13. **NEVER** attempt to connect 2 chargers together.
14. **DO NOT** store the tool in locations where the temperature may reach or exceed 120°F (such as outside sheds or metal buildings in summer).

15. **DO NOT** charge drill when it or air temperature is **BELOW +40°F** or **ABOVE +105°F**.

16. **DO NOT** incinerate the drill even if it is severely damaged or is completely worn out. The batteries can explode in a fire.

A small leakage of liquid from the battery cells may occur under extreme usage, charging or temperature conditions. This does not indicate a failure. However, if the outer seal is broken and this leakage gets on your skin -

- a. Wash quickly with soap and water.
- b. Neutralize with a mild acid such as lemon juice or vinegar.

c. If the battery liquid gets in your eyes, flush them with clean water for a minimum of 10 minutes and seek immediate medical attention. (Medical Note: The liquid is a 25-35% solution of potassium hydroxide.)

17. The **charger** is designed to operate on standard household electrical power (120 volts AC only). Do not attempt to use it on any other voltage!

18. Do not attempt to open the drill housing.

19. **UNPLUG CHARGER WHEN NOT IN USE.**

Table 1 RECOMMENDED MINIMUM AWG\* SIZE FOR EXTENSION CORDS FOR BATTERY CHARGERS YOUR CHARGER'S INPUT RATING IS LESS THAN 2 AMPERES.

AC Input Rating Amperes		AWG* Size of Cord			
Equal to or greater than	But less than	Length of Cord, Feet			
		25	50	100	150
0	2	18	18	18	16

\*American Wire Gauge

## Bubble Level

(9013, 9016 & 9912 only)

Your drill is equipped with a bubble level that assists you in drilling level holes.

For horizontal drilling, tilt the drill up or down as required so that the bubble floats in the center of the parallel lines drawn on the glass. When the bubble is centered between the lines, as shown in Figure 1, the drill is level.

For vertical drilling, align the drill so that the bubble floats in the center of the bull's eye, as shown in Figure 2.

To assure accuracy, first place a level on your workpiece and position the piece so that it's level. Then, when the drill reads level, the two will be aligned. (Any level can only indicate level with respect to the earth's gravitational field.)

**NOTE:** The level is filled with mineral oil that may cause minor skin or eye irritation when contacted. If the level breaks and the fluid gets on your skin, rinse thoroughly with water. If the liquid gets in your eyes, rinse thoroughly with water and contact a physician immediately.

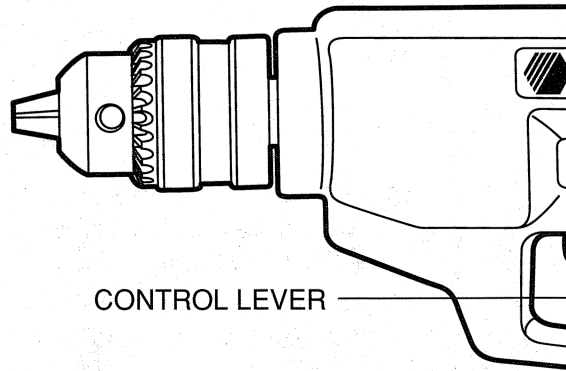
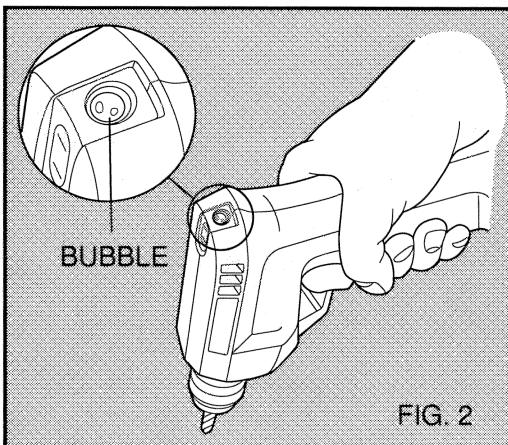
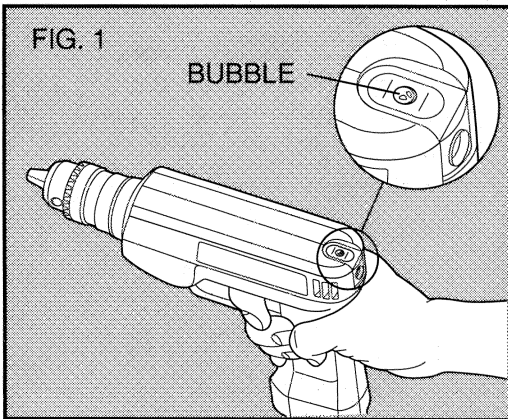

CHARGING SOCKET

SCREWDRIVER BIT  
RELEASE BUTTON

## Screwdriver Bit Storage

A double ended (#2 Phillips and Straight) screwdriver bit is included with your drill. The bit stores in the drill handle, as shown in Figure 3. To remove the bit from the handle, hold the drill normally and depress the button shown in Figure 3. The bit will drop out of the handle. To reinstall into handle, simply push it into the hole as far as it will go. (You may have to twist it slightly in order for it to go all the way in.)

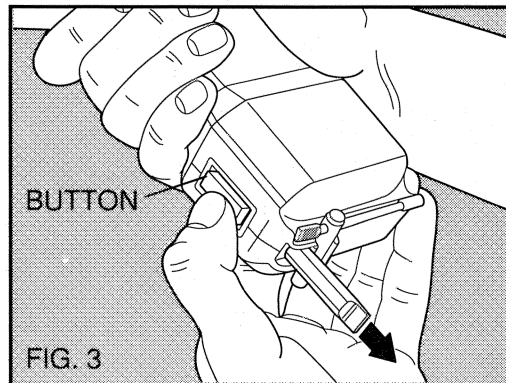

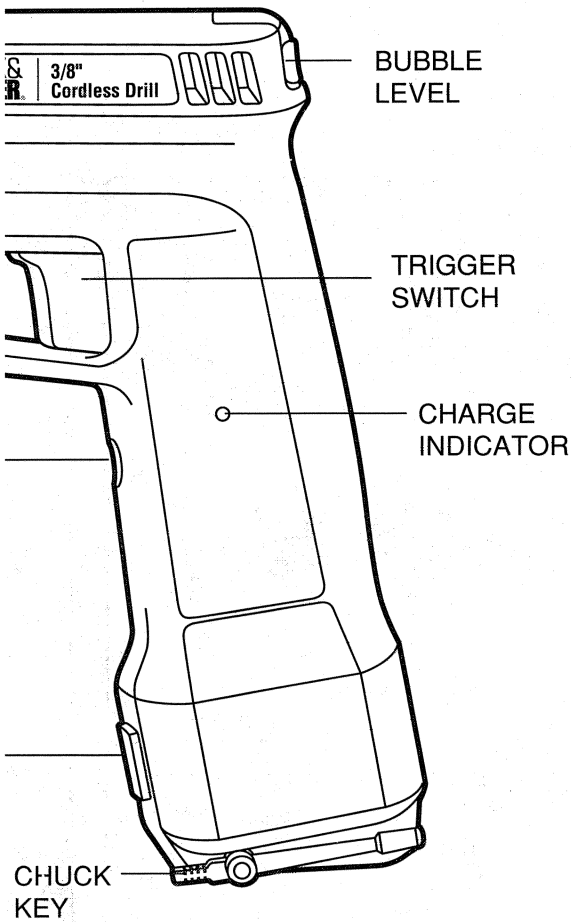

## Trigger Switch and Control Levers

To turn the drill "ON" squeeze the trigger switch shown in Figures 4 & 5. To turn the tool "OFF", release the trigger switch.

Check your drill's nameplate to determine whether it is a two speed or variable speed tool.

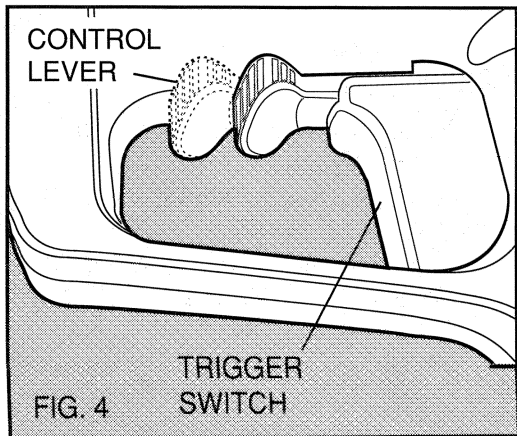

### TWO SPEED SWITCH (9013 only)

The drill has a two speed switch that produces either 300 RPM or 600 RPM. Squeezing the switch just far enough so that the tool runs yields 300 RPM. Squeezing a little farther until you hear the drill speed up produces 600 RPM. NOTE: There is a slight pause between the two speeds. Keep squeezing the trigger and the drill will start again.

The two position Control Lever switches the drill from Forward for drilling holes and driving screws to Reverse for backing out broken drill bits and removing screws.

To run the drill in Forward, pull the Control Lever forward toward the chuck, as shown in Figure 4. To run the drill in Reverse, push the lever back toward the trigger switch.

### VARIABLE SPEED SWITCH (9016, 6091 & 9912 only)

This drill has a variable speed switch. The farther you pull the trigger, the faster the drill will run. The full range is 0 to 600 RPM.

There is no provision for locking the trigger "ON" but the tool can be locked "OFF" as described below. The Control Lever is a three position lever located over the trigger switch, as shown in Figure 5.

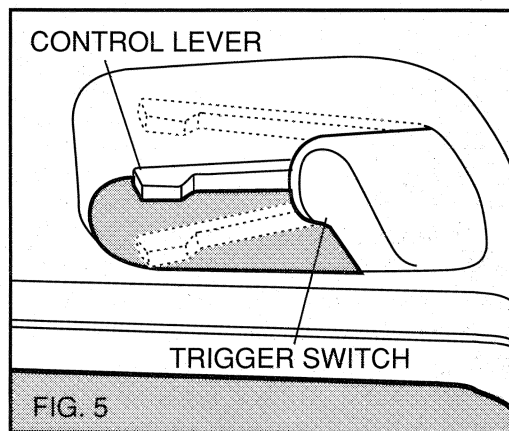

Sliding the lever to the left operates the tool in forward for driving screws or drilling holes. Moving the lever fully to the right operates the tool in reverse for

removing screws or backing out jammed bits. To lock the tool "OFF" to prevent accidental turn on when changing accessories, servicing, charging or storing away, position the Control Lever in the center position, as shown in Figure 5.

Always release the trigger switch when changing the position of the Control Lever. Always store the drill with the Control Lever in the lock "OFF" position.

## Chuck & Key

Turn Chuck collar to open Chuck jaws. Place bit in Chuck as far as it will go. Tighten Chuck collar by hand. Place Chuck Key in each of the three holes, and tighten in clockwise direction (Figure 6). It's important to tighten Chuck with all three holes to prevent slippage. To release bit, turn the Chuck Key counter-clockwise in just one hole, then loosen Chuck by hand.

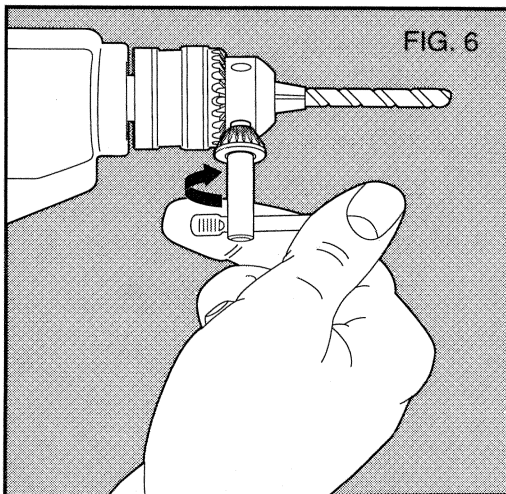

When not in use, the Chuck Key can be stored in the tool. To remove the Key, place thumb as shown in Figure 7 and push key firmly downward out to its holding clip. To replace Key, push firmly and completely up into the socket. (Figure 8.)

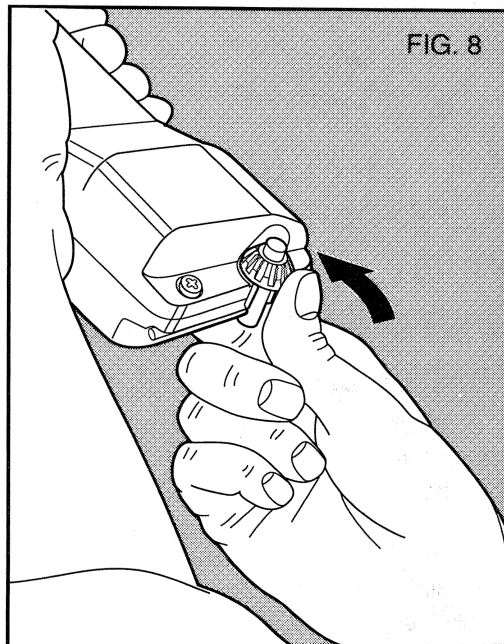
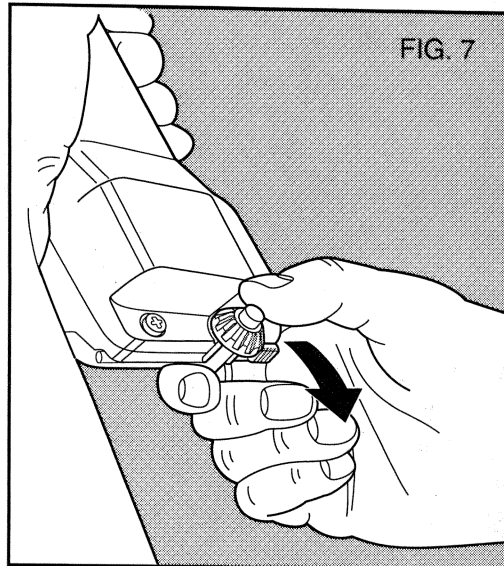

## Charging the Drill

Before attempting to charge your drill, thoroughly read ALL of the safety instructions. To charge your drill, follow the steps below.

1. Put the control lever in the "OFF" position (9016, 6091 and 9912 only) and remove any accessories from the chuck.



## STEPS 2 THROUGH 5 ARE FOR ALL DRILLS COVERED BY THIS MANUAL

2. Plug the output cord of the charger into the socket in the front of the drill handle.
3. Plug the charger into any standard 120 volt electrical outlet.
4. Allow the tool to remain in this condition for three hours.
5. **Unplug the tool from the charger cord, and unplug the charger from the wall.**

## Charge Indicator

Your drill is equipped with a charge indicator light that comes on whenever the drill is charging. The light remains lit whether the drill is fully charged or not and goes out when the tool is taken off charge. The light is located on the side of the handle near the charging socket.

## Important Charging Notes

1. After normal usage, your drill should be fully charged in 3 hours or less. If the drill is run-down completely, it may take up to 5 hours to become fully charged. Your drill was sent from the factory in an uncharged condition. Before attempting to use it, it must be charged for at least 5 hours.
2. **DO NOT** charge the batteries in an air temperature below +40°F or above +105°F. This is important and will prevent serious damage to the batteries.
3. While charging, the charger may hum and become warm to touch. This is a normal condition and does not indicate a problem.
4. If the batteries do not charge properly—(1) Check current at receptacle by plugging in a lamp or other appliance. (2) Check to see if receptacle is connected to a light switch which turns power off when you turn out the lights.

(3) Move charger and drill to a surrounding air temperature of +40°F to 105°F. (4) If the receptacle and temperature are o.k., and you do not get proper charging, take or send the tool and charger to your local Black & Decker Service Center. See "TOOLS ELECTRIC" in yellow pages.

5. The drill should be recharged when it fails to produce sufficient power on the jobs which were easily done previously. **DO NOT CONTINUE** to use the drill with its battery in a depleted condition.
6. To prolong battery life, avoid leaving the tool on charge for more than 5 hours. Although overcharging is not a safety concern, it can significantly reduce overall battery life.
7. A fully charged product, after being off charge for 1 month, will still have 75% of its energy in the battery pack; after 6 months, 50% will remain.
8. Since the unit is designed for cordless applications, use of the unit while plugged in is of no benefit. Batteries will still become depleted.
9. Unplug your tool's charger from the power supply before disconnecting the charger from the tool. Under certain conditions, with the charger plugged in to the power supply, the exposed charging plug can be shorted by foreign material and may cause a fire. Foreign materials of conductive nature, such as but not limited to, steel wool, aluminum foil, or any build up of metallic particles should be kept away from the charging plug. Unplug charger before attempting to clean.
10. Longest life and best performance can be obtained if the batteries are charged when the air temperature is about +75°F. **DO NOT** charge the batteries in an air temperature below +40°F or above 105°F. This is important and may prevent serious damage to the batteries.

## Operation

**FOR LONGEST PRODUCT LIFE, DON'T FORCE TOOL!**

### DRILLING

1. Lock Trigger switch "OFF" (on units so equipped) with Switch Control Lever when attaching or changing bits or accessories.
2. Use sharp drill bits only. For **WOOD**, use twist drill bits, spade bits, power auger bits, or hole saws. For **METAL**, use high-speed steel twist drill bits. For **MASONRY**, such as brick, cement, cinder block, etc., use carbide tipped bits.
3. Be sure the material to be drilled is anchored or clamped firmly. If drilling thin material, use a wood "back-up" block to prevent damage to material.
4. Center-punch an indentation at the point to be drilled. This will overcome tendency of bit to slip around on a smooth surface. Place the tip of bit in indentation and turn motor "ON". See Figure 9.

5. Always apply pressure in a straight line with the bit. Use enough pressure to keep Drill biting, but do not push hard enough to stall motor or deflect bit. To minimize stalling on breaking through the material, reduce pressure on Drill and ease the bit through the last part of hole.
6. Hold Drill firmly to control its twisting action.

### DRILLING IN WOOD

Holes in wood can be made with the same twist drill bits used for metal. These bits should be sharp and should be pulled out frequently when drilling to clear chips from the flutes. Work that is apt to splinter should be backed up with a block of wood. Let up on the pressure just before the tip cuts through, this will give a good clean hole.

### DRILLING IN METAL

Use a cutting lubricant when drilling ferrous metals. The exceptions are iron and brass which should be drilled dry. The cutting lubricants that work best are sulphurized cutting oil or lard oil; bacon grease will also serve the purpose.

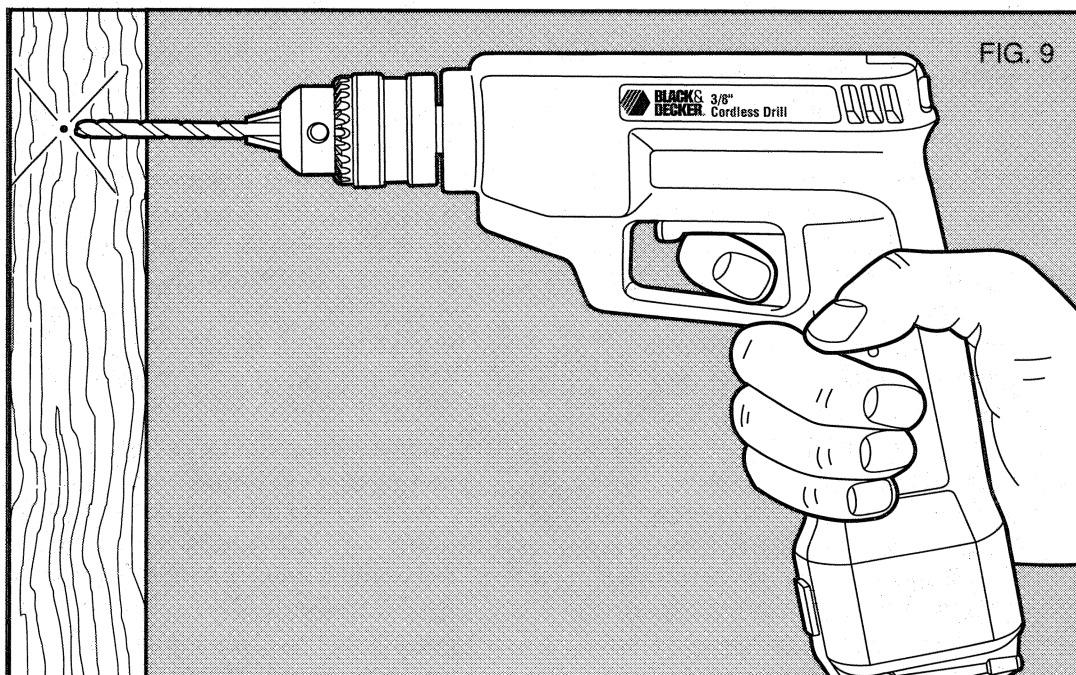

## Cleaning & Lubrication

Use only mild soap and a damp cloth to clean the tool. Do not use gasoline, turpentine, lacquer or paint thinner, dry cleaning fluids or similar products. Never let any liquid get inside the tool; never immerse any part of the tool into a liquid.

Self lubricating bearings are used in the tool and periodic relubrication is not required. In the unlikely event that your drill should ever require service, take or send it to your local Black & Decker Service Center or Authorized Service Station. Service Center addresses are listed on the owner's registration card packed with your drill.

## Storage

1. The best storage place is one that is cool and dry - **away** from direct sunlight, heating pipes and ducts, furnaces, etc.
2. Best storage temperature is approximately +50°F. Do not store where temperatures may go below +40°F or above +120°F. Avoid storage in outside metal buildings where the temperature could go above +120°F in summer, as this could damage the drill.
3. Long storage will not harm the drill or charger. Under the proper conditions (given above) they can be stored for 5 years or more without harm.

## Important

To assure product SAFETY and RELIABILITY, repairs, maintenance and adjustment should be performed by Black & Decker Service Centers or other qualified organizations, always using Black & Decker replacement parts.

## Accessories

The accessories listed in this manual are available at extra cost from your local Dealer or Black & Decker Service Center. A complete listing of service centers is included on the owner's registration card packed with your tool. If you need assistance in locating any accessory, please contact: Black & Decker (U.S.) Inc., Consumer Service Dept., 626 Hanover Pike, P.O. Box 618, Hampstead, MD 21074-0618.

Recommended accessories for your tool are shown in this manual. The use of any other accessory or attachment might be hazardous.

We strongly recommend that you first purchase the No. 72-000 Safety Glasses which should be worn when using all power tools.

For safety in use, the following accessories should be used only in the sizes specified below:

BITS, METAL DRILLING—Up to 3/8".

BITS, MASONRY DRILLING—Up to 3/8".

BITS, WOOD DRILLING—Up to 3/8".

## Holster

This holster fastens to your belt and keeps the tool handy and ready for work. It also frees both hands when you are not actually using the tool.

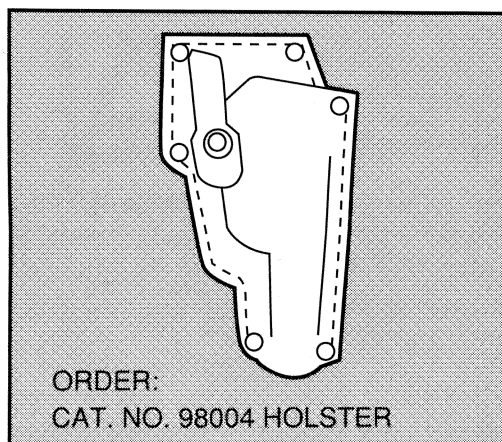

Never holster your drill with a bit in the chuck.

## Automotive Use Warranty (6091 only)

Black & Decker (U.S.) Inc. warrants this product for one year from date of purchase. We will repair without charge, any defects that are due to faulty material or workmanship. Please return the complete unit, transportation prepaid, to any Black & Decker Service Center or Authorized Service Station, listed under "TOOLS ELECTRIC" in the yellow pages for free replacement or repair at our option. This warranty does not apply to accessories or damage caused where repairs have been made or attempted by others.

## Home Use Warranty (A Full Two year Warranty) (9013, 9016 & 9912 only)

Black & Decker (U.S.) Inc. warrants this product for two years against any defects that are due to faulty material or workmanship. Please return the complete unit, transportation prepaid, to the seller (if a participating retailer) for free replacement (proof of purchase may be required). The unit may also be returned to a Black & Decker Service Center or Authorized Service Station, listed under "TOOLS ELECTRIC" in the yellow pages for free replacement or repair at our option. This warranty does not apply to accessories. This warranty gives you specific legal rights and you may have other rights which vary from state to state. Should you have any questions, contact your nearest Black & Decker Service Center Manager.

Like most Black & Decker tools, your drill is listed by Underwriters Laboratories to ensure that it meets stringent safety requirements.

This symbol on the nameplate means the product is listed by Underwriters Laboratories, Inc.



See 'Tools-Electric'  
-Yellow Pages-  
for Service & Sales

Every Black & Decker tool is of the highest quality. If you wish to contact us regarding this product, please call toll free between 8:00 a.m. and 5:00 p.m. EST, Monday through Friday. 1-800-762-6672



**BLACK & DECKER®**

BLACK & DECKER (U.S.) INC., 701 EAST JOPPA ROAD, TOWSON, MD 21204, U.S.A.

9013/9016/9912/6091

Form No. 741380-03  
Copyright © 1992 Black & Decker  
Printed in U.S.A.  
(MAY92-CO-4)